

3RD ANGLE PROJECTION  
DO NOT SCALE

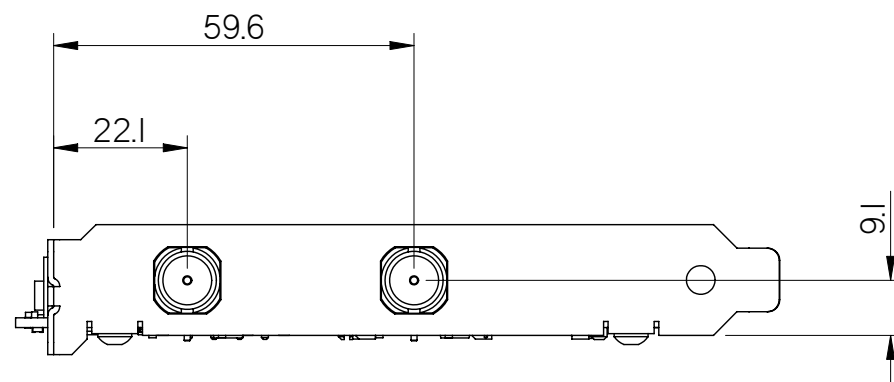

MAX COMPONENT HEIGHT ON THIS SIDE - 14.49mm

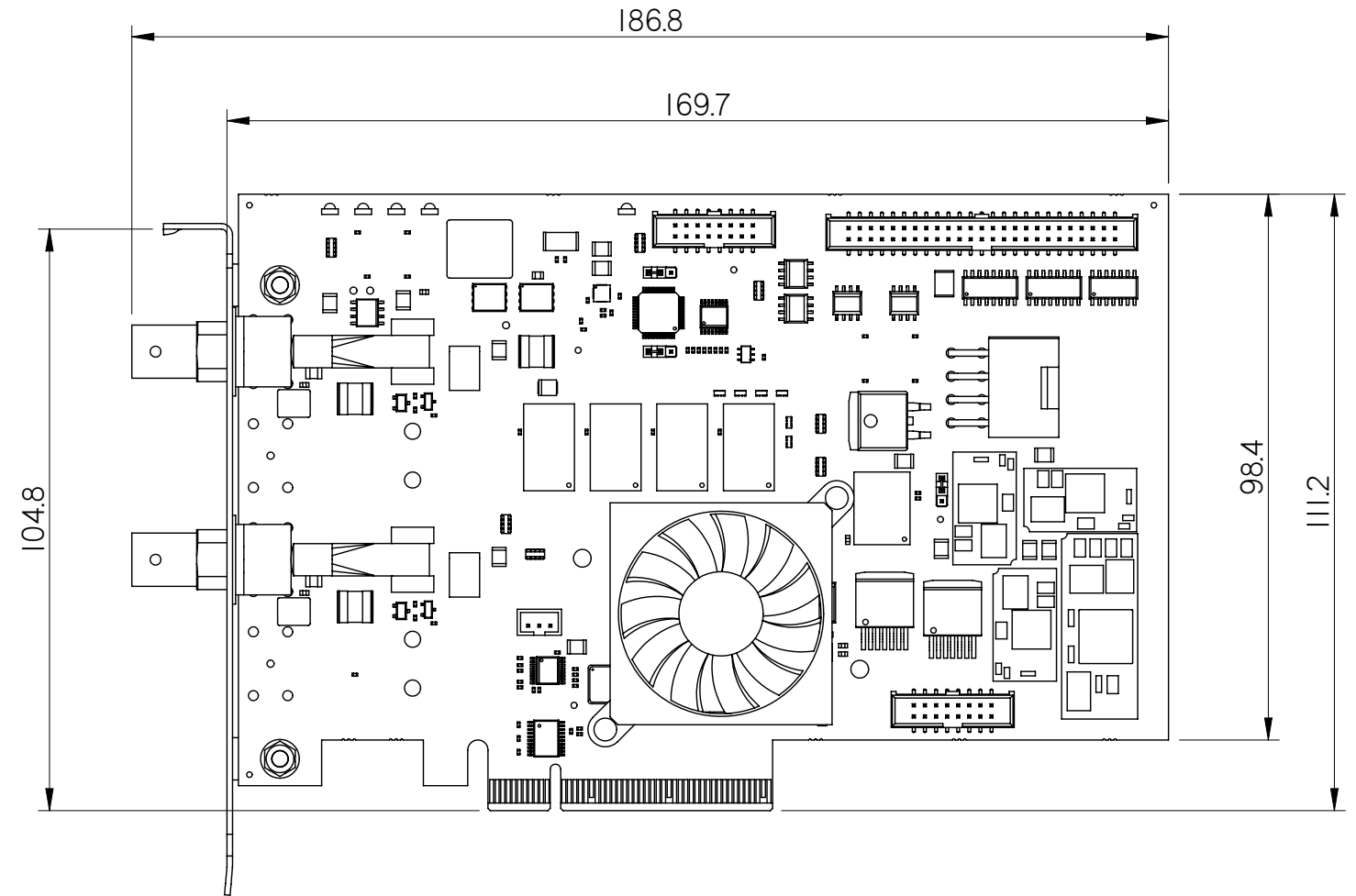
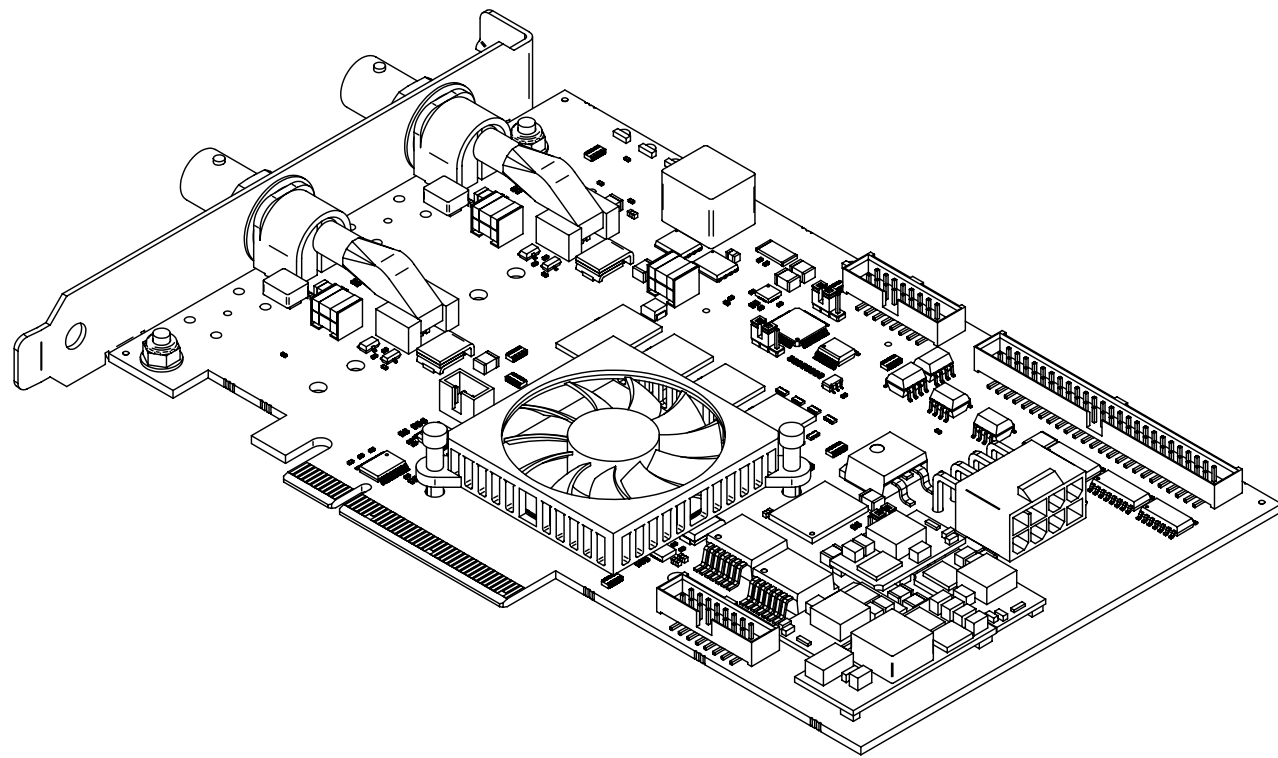
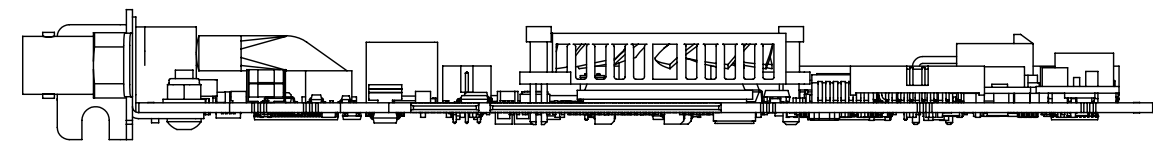

MAX COMPONENT HEIGHT ON THIS SIDE - 2.67mm

NOT TO SCALE

All Dimensions in mm's and for reference only



© 2011-2012 Active Silicon Ltd

This information should not be supplied to a third party without prior consent, in writing, from Active Silicon.

TITLE  
**Mechanical Overview  
FireBird 2XCXP6-2PE8**

DRAWN Keith Baker	DATE 19-Jan-12	APPROVED PL ✓ PE ✓ TD ✓
----------------------	-------------------	----------------------------

DRAWING NUMBER MO-AP20C01-0019-0301	SHT No. -	A 3
--	--------------	--------

Whilst every effort has been made to ensure that the information contained in this drawing and the associated CAD data in electronic form is accurate and correct, Active Silicon cannot be held liable for errors or omissions. Should any errors or omissions be discovered, Active Silicon will use all reasonable endeavours to correct and re-issue the drawings and CAD data as fast as practical.

Please note that some electrical components can vary slightly in size from batch to batch and for that reason any mechanical design integration should use the maximum component height plane as shown in this drawing and not individual component heights.